



АВАРИЙНЫЕ ДУШИ И
ФОНТАНЫ ДЛЯ ГЛАЗ IST
КАТАЛОГ-ПРАЙС-ЛИСТ

С РАЗМЕРАМИ
ООО "ТИ-СИСТЕМС"

EMERGENCY SHOWERS
and
EYEWASH FOUNTAINS
CATALOGUE

www.tisys.ru +7 495 777 4788
info@tisys.ru

EN 15154-1

EN 15154-2

ЦЕНЫ В ЕВРО С НДС СКЛАД МОСКВА
ДОСТАВКА В ЛЮБОЙ РЕГИОН РФ И СНГ
КОМПАНИЕЙ "ДЕЛОВЫЕ ЛИНИИ"
ДЕЙСТВИТЕЛЬНЫ ПРИ ЗАКАЗЕ ОТ 2000 ЕВРО

IST Co. Ltd.



C

E

T

S

I

Wall Mounted
With Flange



Монтаж на стену

P/n:15011000

450 евро

**Stainless Steel
Push Handle Control**

Pipes : Stainless Steel
Bowl : Stainless Steel or ABS Plastic
Water Inlet : 1/2"
Waste Outlet : 1 1/4"
Water Flow : minimum 6 lt/min
Total Weight : 5,800 kg(SS) - 4,750 kg (ABS)
Packed Dimensions :
HxWxD mm : 320x320x220

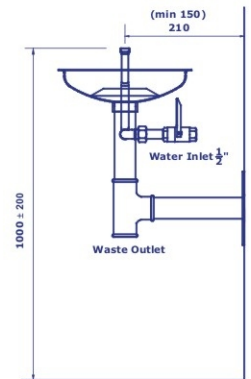

Wall Mounted
With Flange



Монтаж на стену

P/n:15011500

400 евро

**Galvanised and Painted
Push Handle Control**

Pipes : Galvanised and painted
Bowl : Painted Steel or ABS Plastic
Water Inlet : 1/2"
Waste Outlet : 1 1/4"
Water Flow : minimum 6 lt/min
Total Weight : 6,150 kg(Galv.) - 5,100 kg (ABS)
Packed Dimensions :
HxWxD mm : 320x320x220

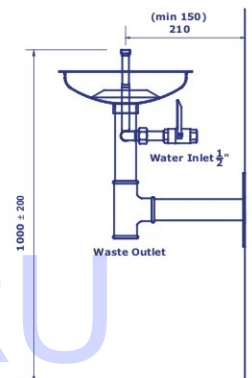

Wall Mounted
With Bracket



Монтаж на стену

P/n:15011100

500 евро

**Stainless Steel
Push Handle Control
With Bracket**

Pipes : Stainless Steel
Bowl : Stainless Steel or ABS Plastic
Water Inlet : 1/2"
Waste Outlet : 1 1/2"
Water Flow : minimum 6 lt/min
Total Weight : 5,950 kg (SS)- 4,900 kg (ABS)
Packed Dimensions :
HxWxD mm : 320x320x220

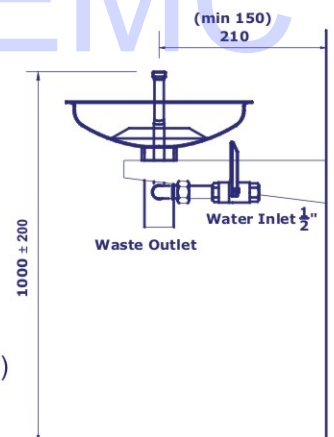

Wall Mounted
With Bracket



Монтаж на стену

P/n:15011600

430 евро

**Galvanised and Painted
Push Handle Control
With Bracket**

Pipes : Galvanised and Painted
Bowl : Painted Steel or ABS Plastic
Water Inlet : 1/2"
Waste Outlet : 1 1/2"
Water Flow : minimum 6 lt/min
Total Weight : 5,950 kg (Galv.)-4,900 kg(ABS)
Packed Dimensions :
HxWxD mm : 320x320x220 mm

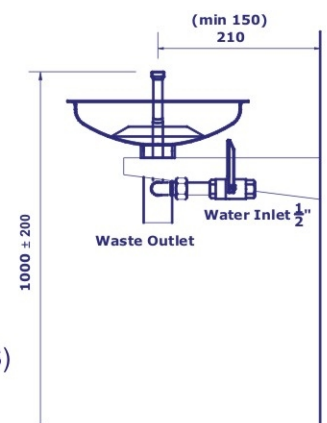

Wall Mounted
With Flange



550 евро

Монтаж на стену

P/n:15011200

P/n:15011700

430 евро

Stainless Steel
Treadle Foot Control

Galvanised and Painted
Treadle Foot Control

Pipes :Galvanised or Stainless Steel
Bowl : Stainless Steel or ABS Plastic
Galvanised or ABS Plastic

Water Inlet : 1/2"

Waste Outlet : 1 1/4"

Water Flow : minimum 6 lt/min

Total Weight : 7,050 kg (SS) - 6,000 kg (ABS)
7,400 kg (Galv.)- 6,350 kg (ABS)

Packed Dimensions :

HxWxD mm : 810x320x170

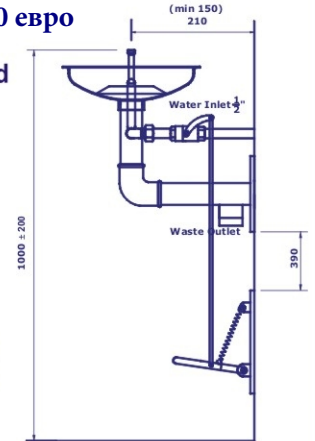

Wall Mounted
With Flange



600 евро

Монтаж на стену

P/n:15011300

P/n:15011800

440 евро

Stainless Steel
Push Handle Control

Galvanised and Painted
Push Handle Control

Pipes :Galvanised or Stainless Steel
Bowl : Stainless Steel or Galvanised

Water Inlet : 1/2"

Waste Outlet : 1 1/4"

Water Flow : minimum 6 lt/min

Total Weight : 7,350 kg (SS)

7,700 kg (Galv.)

Packed Dimensions :

HxWxD mm : 320x320x220 mm

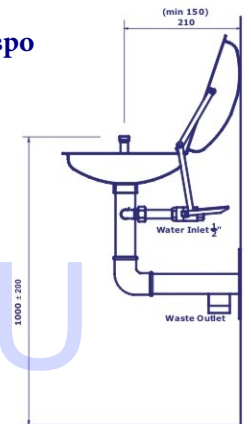

Countertop Mounted



Монтаж на поверхность

P/n:15012000

430 евро

Stainless Steel
Push Handle Control

Pipes :Stainless Steel

Bowl : Stainless Steel or ABS Plastic

Water Inlet : 1/2"

Waste Outlet : 1 1/2"

Water Flow : minimum 6 lt/min

Total Weight : 5,050 kg (SS) - 4,000 kg (ABS)

Packed Dimensions :

HxWxD mm : 320x320x220

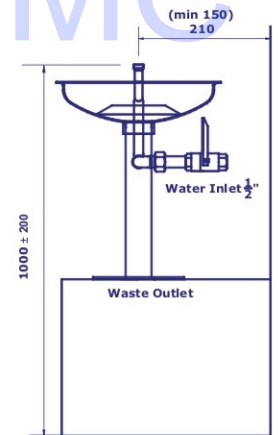

Countertop Mounted



Монтаж на поверхность

P/n:15012500

370 евро

Galvanised and Painted
Push Handle Control

Pipes :Galvanised and Painted

Bowl : Painted Steel or ABS Plastic

Water Inlet : 1/2"

Waste Outlet : 1 1/2"

Water Flow : minimum 6 lt/min

Total Weight : 5,350 kg (Galv.) - 4,300 kg (ABS)

Packed Dimensions :

HxWxD mm : 320x320x220

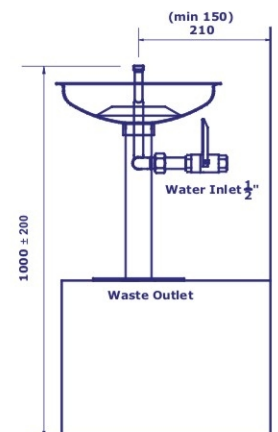

Pedestal Mounted



Монтаж на пол

P/n:15013000

640 евро

**Stainless Steel
Push Handle Control**

Pipes : Stainless Steel
Bowl : Stainless Steel or ABS Plastic
Water Inlet : 1/2"
Waste Outlet : 1 1/4"
Water Flow : minimum 6 lt/min
Total Weight : 9,600 kg (SS) - 8,550 kg (ABS)
Packed Dimensions :
HxWxD mm : 810x320x220

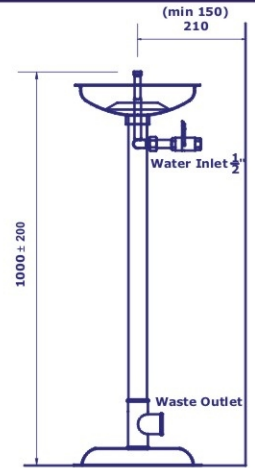

Pedestal Mounted



Монтаж на пол

P/n:15013500

490 евро

**Galvanised and Painted
Push Handle Control**

Pipes : Galvanised and Painted
Bowl : Painted Steel or ABS Plastic
Water Inlet : 1/2"
Waste Outlet : 1 1/4"
Water Flow : minimum 6 lt/min
Total Weight : 9,950 kg (Galv.) - 8,900 kg (ABS)
Packed Dimensions :
HxWxD mm : 810x320x220

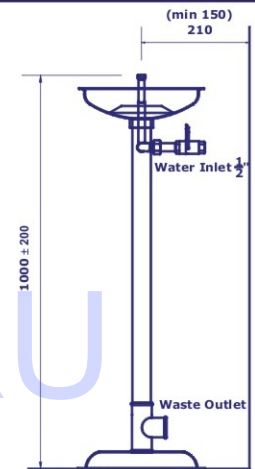

Pedestal Mounted



Монтаж на пол

P/n:15014000

700 евро

**Stainless Steel
Treadle Foot Control**

Pipes : Stainless Steel
Bowl : Stainless Steel or ABS Plastic
Water Inlet : 1/2"
Waste Outlet : 1 1/4"
Water Flow : minimum 6 lt/min
Total Weight : 10,400 kg (SS) - 9,350 kg (ABS)
Packed Dimensions :
HxWxD mm : 810x320x220

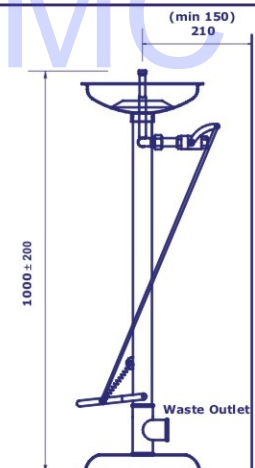

Pedestal Mounted



Монтаж на пол

P/n:15014500

530 евро

**Galvanised and Painted
Treadle Foot Control**

Pipes : Galvanised and Painted
Bowl : Painted Steel or ABS Plastic
Water Inlet : 1/2"
Waste Outlet : 1 1/4"
Water Flow : minimum 6 lt/min
Total Weight : 10,750 kg (Galv.) - 9,700 kg (ABS)
Packed Dimensions :
HxWxD mm : 810x320x220

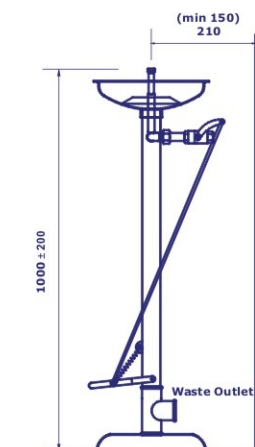

Freeze-Proof
With automatic valve



1240 евро

Монтаж на пол

P/n:15016000

P/n:15016500

1110 евро

Stainless Steel

Galvanised and Painted

Push Handle Control

Push Handle Control

Pipes :Galvanised or Stainless Steel
Bowl : Stainless Steel or ABS Plastic
Galvanised or ABS Plastic

Water Inlet : 1/2"

Waste Outlet : 1 1/4"

Water Flow : minimum 6 lt/min

Total Weight : 9,950 kg (SS) - 8,900 kg (ABS)

10,250 kg (Galv.)- 9,200 kg (ABS)

Packed Dimensions :

HxWxD mm : 810x320x220

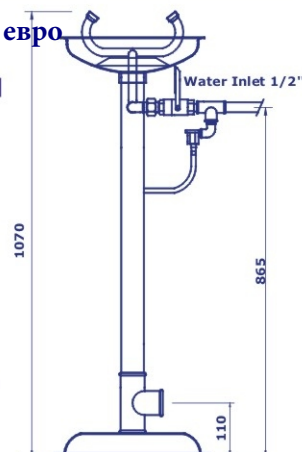

Freeze-Proof
With underground valve



800 евро

Монтаж на пол с подземным подключением

P/n:15017000

P/n:15017500

700 евро

Stainless Steel

Galvanised and Painted

Treadle Foot Control

Treadle Foot Control

Pipes :Galvanised or Stainless Steel

Bowl : Stainless Steel or Galvanised

Water Inlet : 1/2"

Waste Outlet : 1 1/4"

Water Flow : minimum 6 lt/min

Total Weight : 13,950 kg (SS)

14,750 kg (Galv.)

Packed Dimensions :

HxWxD mm : 810x320x220

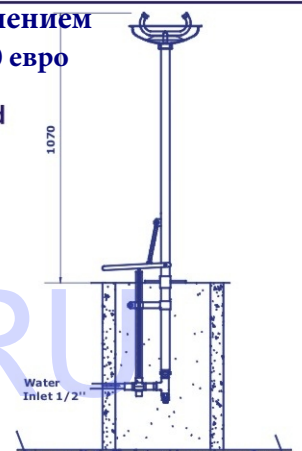

Pedestal with support



1100 евро

P/n:15015000

P/n:15015500

1000 евро

Stainless Steel
Panel Control

Galvanised and
painted
Panel Control

Pipes : Galvanised or Stainless Steel

Bowl : Stainless Steel or ABS Plastic

Water Inlet : 1"

Waste Outlet : 1 1/4"

Water Flow : minimum 6 lt/min

Total Weight :

30,750 kg (SS) - 29,700 kg (ABS)

31,750 kg (Galv.)- 30,700 kg (ABS)

Packed Dimensions:

HxWxD mm : 950x850x280

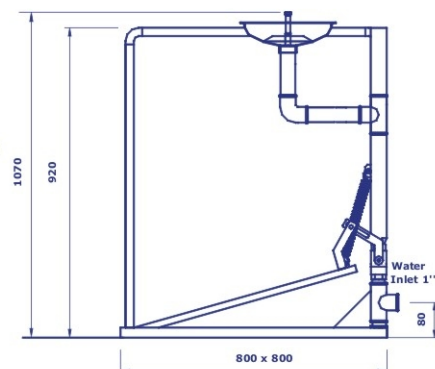

Платформенная модель фонтана

Countertop Mounted
Laboratory



300 евро

Лабораторная модель фонтана

P/n:15012020

P/n:15012525

250 евро

Stainless Steel

Galvanised and Painted

Push Handle Control

Push Handle Control

Pipes :Galvanised and Painted

Bowl : Painted Steel or ABS Plastic

Water Inlet : 1/2"

Water Flow : minimum 6 lt/min

Total Weight : 2,100 kg (SS)

2,200 (Galv.)

Packed Dimensions :

HxWxD mm : 320x320x150

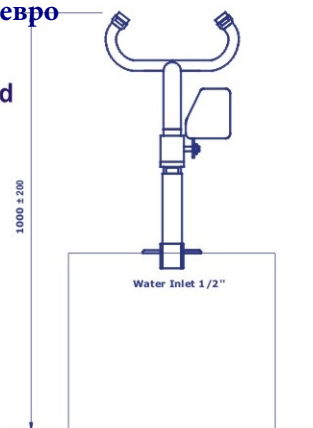

Pedestal Mounted



1200 евро

P/n:15031000

Монтаж на пол

Stainless Steel
Push Handle for Eyebath
Pull Rod Control for Shower

Pipes :Stainless Steel
Bowl : Stainless Steel or ABS Plastic
Showerhead : Stainless Steel or ABS Plastic
Water Inlet : 1"
Waste Outlet : 1 1/4"
Water Flow : minimum 6 lt/min (Eyewash)
 minimum 60 lt/min (Shower)
Total Weight : 20,500 kg (SS) - 18,300 (ABS)
Packed Dimensions:
HxWxD mm : 860x350x250

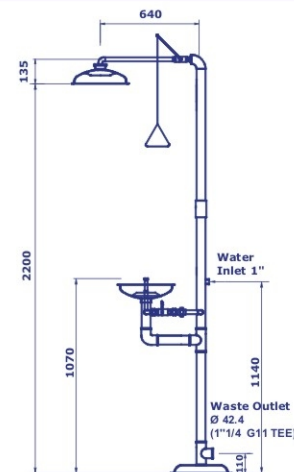

Pedestal Mounted



850 евро

P/n:15031500

Монтаж на пол

Galvanised and Painted
Push Handle for Eyebath
Pull Rod Control for Shower

Pipes :Galvanised and Painted
Bowl : Painted Steel or ABS Plastic
Showerhead : Painted Steel or ABS Plastic
Water Inlet : 1"
Waste Outlet : 1 1/4"
Water Flow : minimum 6 lt/min (Eyewash)
 minimum 60 lt/min (Shower)
Total Weight : 21,500 kg (SS) - 19,300 kg (ABS)
Packed Dimensions:
HxWxD mm : 860x350x250

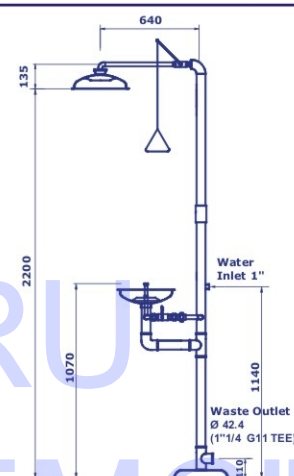

Pedestal Mounted



1350 евро

P/n:15032000

Монтаж на пол

Stainless Steel
Treadle Foot Control Eyebath
Pull Rod Control for Shower

Pipes :Stainless Steel
Bowl : Stainless Steel or ABS Plastic
Showerhead : Stainless Steel or ABS Plastic
Water Inlet : 1"
Waste Outlet : 1 1/4"
Water Flow : minimum 6 lt/min (Eyewash)
 minimum 60 lt/min (Shower)
Total Weight : 21,400 kg (SS) - 19,200 kg (ABS)
Packed Dimensions:
HxWxD mm : 860x350x250

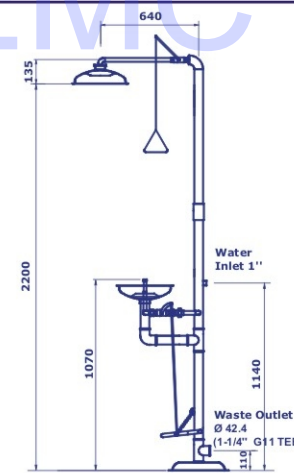

Pedestal Mounted



900 евро

P/n:15032500

Монтаж на пол

Galvanised and Painted
Treadle Foot Control Eyebath
Pull Rod Control for Shower

Pipes :Galvanised and Painted
Bowl : Painted Steel or ABS Plastic
Showerhead : Painted Steel or ABS Plastic
Water Inlet : 1"
Waste Outlet : 1 1/4"
Water Flow : minimum 6 lt/min (Eyewash)
 minimum 60 lt/min (Shower)
Total Weight : 22,400 kg (Galv.) - 20,200 kg (ABS)
Packed Dimensions:
HxWxD mm : 860x350x250

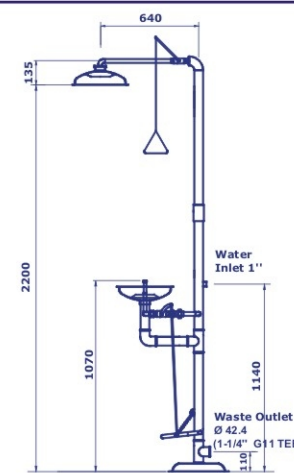

Wall Mounted



1060 евро

P/n:15034000

Монтаж на стену

Stainless Steel
Push Handle for Eyebath
Pull Rod Control for Shower
 Pipes :Stainless Steel
 Bowl : Stainless Steel or ABS Plastic
 Showerhead : Stainless Steel or ABS Plastic
 Water Inlet : 1"
 Waste Outlet : 1 1/4"
 Water Flow : minimum 6 lt/min (Eyewash)
 minimum 60 lt/min (Shower)
 Total Weight : 17,550 kg (SS) - 15,350 kg (ABS)
 Packed Dimensions:
 HxWxD mm : 860x350x250

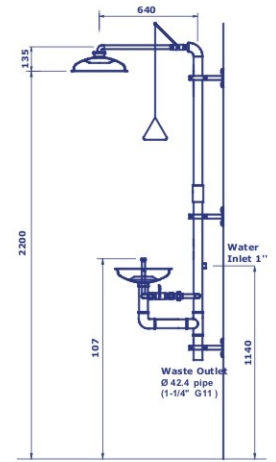

Wall Mounted



750 евро

P/n:15034500

Монтаж на стену

Galvanised and painted
Push Handle for Eyebath
Pull Rod Control for Shower
 Pipes :Galvanised and Painted
 Bowl : Painted Steel or ABS Plastic
 Showerhead : Painted Steel or ABS Plastic
 Water Inlet : 1"
 Waste Outlet : 1 1/4"
 Water Flow : minimum 6 lt/min (Eyewash)
 minimum 60 lt/min (Shower)
 Total Weight : 18,200 kg (Galv.) - 16,000 kg (ABS)
 Packed Dimensions:
 HxWxD mm : 860x350x250

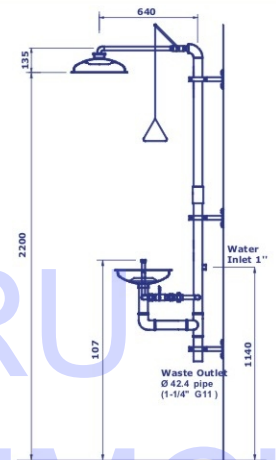

Pedestal Mounted
with support

Платформенная
модель с
поручнями



2550 евро

P/n:15035000

P/n:15035500

1655 евро

Stainless Steel
Treadle Foot Control for Eyebath
Panel Control for Shower
 Pipes :Galvanised or Stainless Steel
 Bowl : Painted Steel, Stainless Steel or ABS Plastic
 Showerhead : Painted Steel, Stainless Steel or ABS Plastic
 Water Inlet : 1"
 Waste Outlet: 1 1/4"
 Water Flow : minimum 6 lt/min (Eyewash)
 minimum 60 lt/min (Shower)
 Total Weight : 43,050 kg (SS) - 40,950 kg (ABS)
 44,050 kg (Galv.) - 41,950 kg (ABS)
 Packed Dimensions:HxWxD mm : 950x850x280 mm

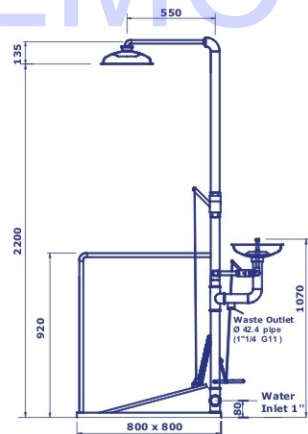

Pedestal Mounted
with mini panel

Платформенная
модель



1900 евро

P/n:15038000

P/n:15038500

1650 евро

Stainless Steel
Treadle Foot Control for Eyebath
Panel Control for Shower
 Pipes :Galvanised or Stainless Steel
 Bowl : Painted Steel, Stainless Steel or ABS Plastic
 Showerhead : Painted Steel, Stainless Steel or ABS Plastic
 Water Inlet : 1"
 Waste Outlet: 1 1/4"
 Water Flow : minimum 6 lt/min (Eyewash)
 minimum 60 lt/min (Shower)
 Total Weight : 34,250 kg (SS) - 32,150 kg (ABS)
 35,250 kg (Galv.) - 33,150 kg (ABS)
 Packed Dimensions:HxWxD mm : 850x690x280 mm

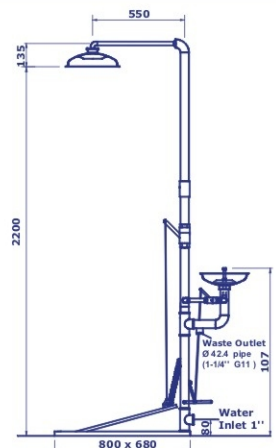

Freeze - Proof with automatic valve water inlet from ground



1800 евро

P/n:15036000

Stainless Steel
Push Handle for Eyebath
Pull Rod Control for Shower

Pipes :Stainless Steel
Bowl : Stainless Steel or ABS Plastic
Showerhead : Stainless Steel or ABS Plastic
Water Inlet : 1"
Waste Outlet : 1 1/4"
Water Flow : mininum 6 lt/min (Eyewash)
mininum 60 lt/min (Shower)
Total Weight : 20,950 kg (SS) - 18,850kg (ABS)
21,950 kg (Galv.) - 19,850 kg (ABS)

Packed Dimensions:
HxWxD mm : 860x340x250

P/n:15036500

Galvanised and painted
Push Handle for Eyebath
Pull Rod Control for Shower

1600 евро

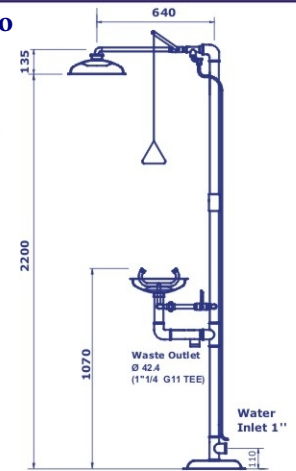

С защитой от замерзания

Freeze - Proof with automatic valve water inlet from up



1980 евро

P/n:15036060

Stainless Steel
Push Handle for Eyebath
Pull Rod Control for Shower

Pipes :Stainless Steel
Bowl : Stainless Steel or ABS Plastic
Showerhead : Stainless Steel or ABS Plastic
Water Inlet : 1"
Waste Outlet : 1 1/4"
Water Flow : mininum 6 lt/min (Eyewash)
mininum 60 lt/min (Shower)
Total Weight : 20,950 kg (SS) - 18,850kg (ABS)
21,950 kg (Galv.) - 19,850 kg (ABS)

Packed Dimensions:
HxWxD mm : 860x340x250

P/n:15036565

Galvanised and painted
Push Handle for Eyebath
Pull Rod Control for Shower

1550 евро

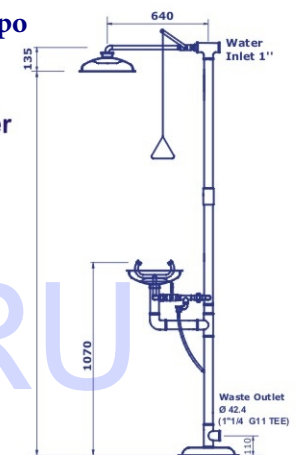

С защитой от замерзания

Freeze - Proof with underground valve



запрос

P/n:15039000

Stainless Steel
Treadle Foot Control
Push Handle for Shower

Pipes :Stainless Steel
Bowl : Stainless Steel or ABS Plastic
Showerhead : Stainless Steel or ABS Plastic
Water Inlet : 1"
Water Flow : mininum 6 lt/min (Eyewash)
mininum 60 lt/min (Shower)
Total Weight : 24,500 kg (SS) - 22,400 kg (ABS)
25,500 kg (Galv.) - 23,400 kg (ABS)

Packed Dimensions:
HxWxD mm : 860x340x250

P/n:15039500

Galvanised and painted
Treadle Foot Control
Push Handle for Shower

запрос

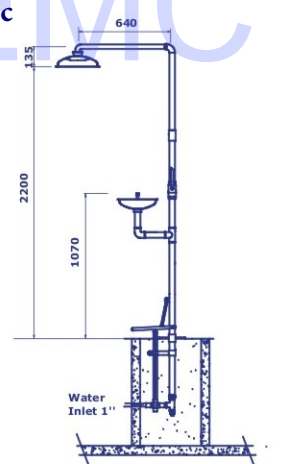

С клапаном подземным

Freeze - Proof with double valve



запрос

P/n:15038080

Stainless Steel
Panel Control +
Push Handle Control

Pipes :Galvanised or Stainless Steel
Bowl : Painted Steel, Stainless Steel or ABS Plastic
Showerhead : Painted Steel, Stainless Steel or ABS Plastic
Water Inlet : 1"
Waste Outlet: 1 1/4"
Water Flow : mininum 6 lt/min (Eyewash)
mininum 60 lt/min (Shower)
Total Weight : 34,250 kg (SS) - 32,150 kg (ABS)
35,250 kg (Galv.) - 33,150 kg (ABS)

Packed Dimensions:HxWxD mm : 1100x700x280 mm

P/n:15038585

Galvanised and painted
Panel Control +
Push Handle Control

запрос

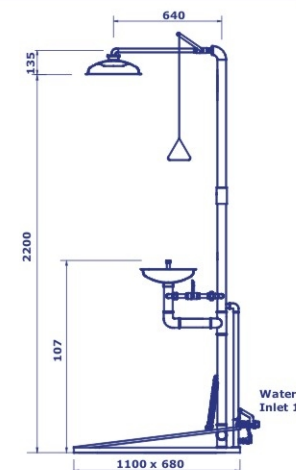

Самодренлируемый платформенный

Pedestal Mounted



850 евро

P/n:15021000

Напольная модель

Stainless Steel
Pull Rod Control

Pipes :Stainless Steel
Showerhead : Stainless Steel or ABS Plastic
Water Inlet : 1"
Water Flow : minimum 60 lt/min (Shower)
Total Weight : 14,500 kg (SS) - 13,450 (ABS)
Packed Dimensions:
HxWxD mm : 810x320x220

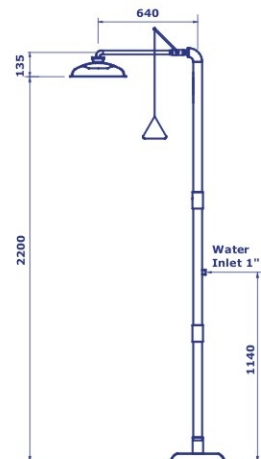

Pedestal Mounted



550 евро

P/n:15021500

Напольная модель

Galvanised and Painted
Pull Rod Control

Pipes :Galvanised and Painted
Showerhead : Painted Steel or ABS Plastic
Water Inlet : 1"
Water Flow : minimum 60 lt/min (Shower)
Total Weight : 15,250 kg (Gal.) - 14,200 (ABS)
Packed Dimensions:
HxWxD mm : 810x320x220

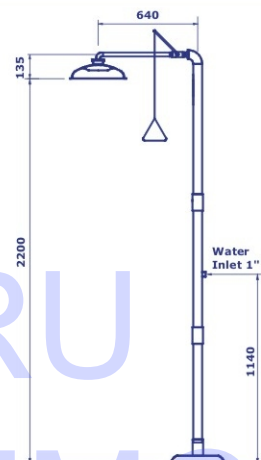

Pedestal Mounted



920 евро

P/n:15022000

Напольная модель

Stainless Steel
Treadle Foot Control

Pipes :Stainless Steel
Showerhead : Stainless Steel or ABS Plastic
Water Inlet : 1"
Water Flow : minimum 60 lt/min (Shower)
Total Weight : 15,400 kg (SS) - 14,350 (ABS)
Packed Dimensions:
HxWxD mm : 810x320x220

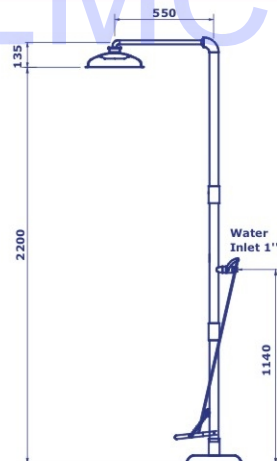

Pedestal Mounted



650 евро

P/n:15022500

Напольная модель

Galvanised and Painted
Treadle Foot Control

Pipes :Galvanised and Painted
Showerhead : Painted Steel or ABS Plastic
Water Inlet : 1"
Water Flow : minimum 60 lt/min (Shower)
Total Weight : 16,100 kg (Gal.) - 15,050 (ABS)
Packed Dimensions:
HxWxD mm : 810x320x220

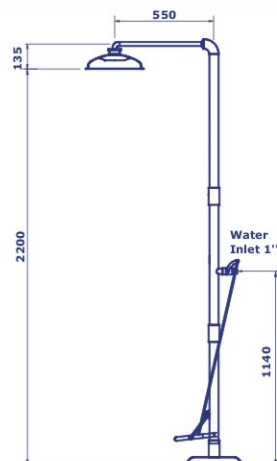

Wall Mounted
with exposed piping



630 евро

P/n:15023000

Установка на стену

Stainless Steel
Pull Rod Control for Shower

Pipes : Stainless Steel
Showerhead : Stainless Steel or ABS Plastic
Water Inlet : 1"
Water Flow : minimum 60 lt/min (Shower)
Total Weight : 11,150 kg (SS) - 10,100 kg (ABS)
Packed Dimensions:
HxWxD mm : 820x320x170

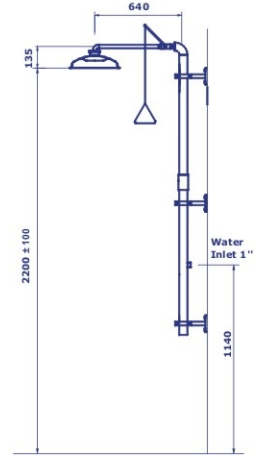

Wall Mounted
with exposed piping



460 евро

P/n:15023500

Установка на стену

Galvanised and painted
Pull Rod Control for Shower

Pipes : Galvanised and Painted
Showerhead : Painted Steel or ABS Plastic
Water Inlet : 1"
Water Flow : minimum 60 lt/min (Shower)
Total Weight : 11,750 kg (Galv.) - 10,700 kg (ABS)
Packed Dimensions:
HxWxD mm : 820x320x170

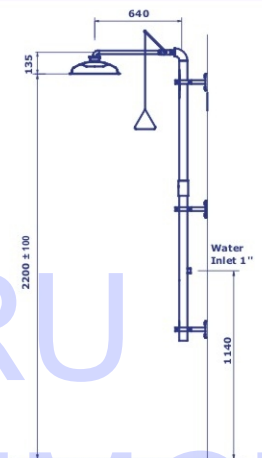

Wall Mounted
with ball valve



440 евро

P/n:15024000

Установка на стену

Stainless Steel
Pull Rod Control for Shower

Pipes : Stainless Steel
Showerhead : Stainless Steel or ABS Plastic
Water Inlet : 1"
Water Flow : minimum 60 lt/min (Shower)
Total Weight : 5,250 kg (SS) - 4,200 kg (ABS)
Packed Dimensions:
HxWxD mm : 820x320x170

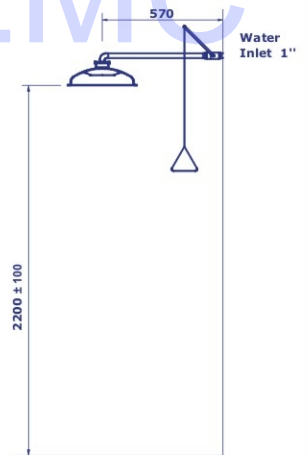

Wall Mounted
with ball valve



350 евро

P/n:15024500

Установка на стену

Galvanised and painted
Pull Rod Control for Shower

Pipes : Galvanised and Painted
Showerhead : Painted Steel or ABS Plastic
Water Inlet : 1"
Water Flow : minimum 60 lt/min (Shower)
Total Weight : 5,450 kg (Galv.) - 4,400 kg (ABS)
Packed Dimensions:
HxWxD mm : 820x320x170

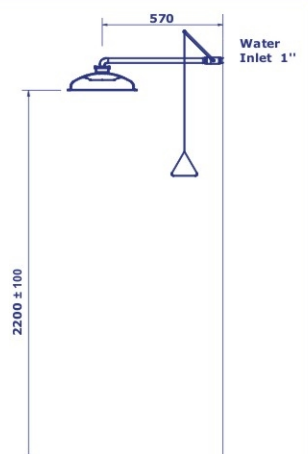

Freeze - Proof with automatic valve water inlet from ground



по запросу

P/n:15026000

**Stainless Steel
Pull Rod Control for Shower**

P/n:15026500

**Galvanised and painted
Pull Rod Control for Shower**

Pipes : Galvanised or Stainless Steel
Showerhead : Painted Steel, Stainless Steel or ABS Plastic
Water Inlet : 1"
Water Flow : minimum 60 lt/min (Shower)
Total Weight : 14,950 kg (SS) - 13,900 kg (ABS)
15,700 kg (Galv.) - 14,650 kg (ABS)

Packed Dimensions:
HxWxD mm : 810x320x220

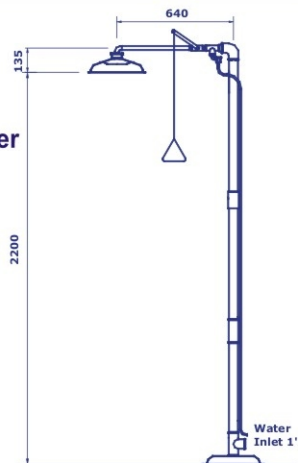

С защитой от замерзания

Freeze - Proof with underground valve



по запросу

P/n:15027000

**Stainless Steel
Pull Rod Control for Shower**

P/n:15027500

**Galvanised and painted
Pull Rod Control for Shower**

Pipes : Galvanised or Stainless Steel
Showerhead : Painted Steel, Stainless Steel or ABS Plastic
Water Inlet : 1"
Water Flow : minimum 60 lt/min (Shower)
Total Weight : 19,250 kg (SS) - 18,200 kg (ABS)
20,250 kg (Galv.) - 19,200 kg (ABS)

Packed Dimensions:
HxWxD mm : 810x320x220

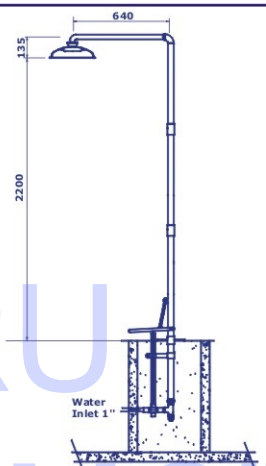

С защитой от замерзания подземный клапан

Freeze - Proof with behind wall valve



по запросу

P/n:15024010

**Stainless Steel
Push handle Control**

P/n:15024510

**Galvanised and painted
Push handle Control**

Pipes : Galvanised or Stainless Steel
Showerhead : Painted Steel, Stainless Steel or ABS Plastic
Water Inlet : 1"
Water Flow : minimum 60 lt/min (Shower)
Total Weight : 19,250 kg (SS) - 18,200 kg (ABS)
20,250 kg (Galv.) - 19,200 kg (ABS)

Packed Dimensions:
HxWxD mm : 810x320x220

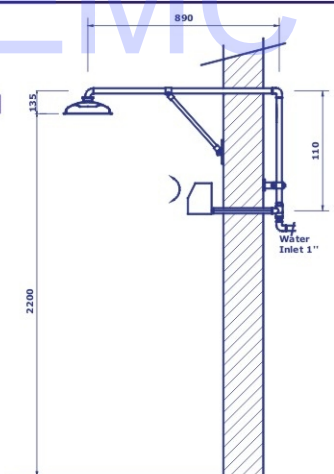

Защита от замерзания клапан за стеной

Freeze - Proof with double valve



по запросу

P/n:15028080

**Stainless Steel
Panel Control**

P/n:15028585

**Galvanised and painted
Panel Control**

Pipes : Galvanised or Stainless Steel
Showerhead : Painted Steel, Stainless Steel or ABS Plastic
Water Inlet : 1"
Water Flow : minimum 60 lt/min (Shower)
Total Weight : 31,750 kg (SS) - 30,700 kg (ABS)
32,750 kg (Galv.) - 31,700 kg (ABS)

Packed Dimensions: HxWxD mm : 1100x700x280 mm

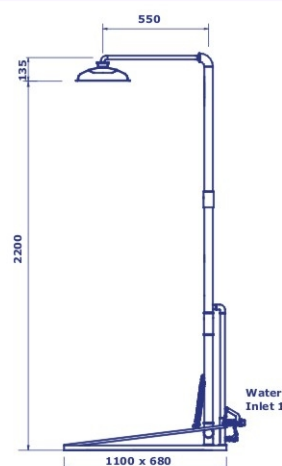

С защитой от замерзания двойной дренажный клапан

Pedestal Mounted with support



по запросу

P/n:15025000

P/n:15025500

**Stainless Steel
Support Control**

**Galvanised and painted
Support Control**

Pipes : Galvanised or Stainless Steel
 Showerhead : Stainless Steel or ABS Plastic
 Water Inlet : 1"
 Water Flow : minimum 60 lt/min (Shower)
 Total Weight : 35,550 kg (SS) - 34,500 kg (ABS)
 36,250 kg (Galv.)- 35,200 kg (ABS)
 Packed Dimensions:
 HxWxD mm : 950x850x280

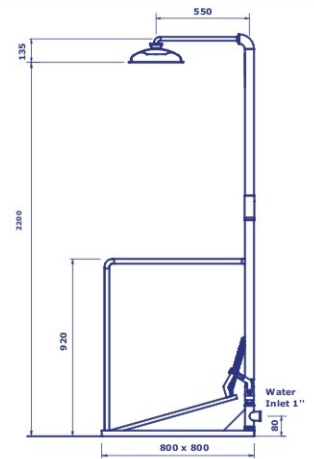

Платформенный с поддержкой

Pedestal Mounted with mini panel



по запросу

P/n:15028000

P/n:15028500

**Stainless Steel
Panel Control**

**Galvanised and painted
Panel Control**

Pipes : Galvanised or Stainless Steel
 Showerhead : Stainless Steel or
 ABS Plastic
 Water Inlet : 1"
 Water Flow : minimum 60 lt/min (Shower)
 Total Weight : 28,250 kg (SS) - 27,200 kg (ABS)
 28,900 kg (Galv.)- 27,850 kg (ABS)
 Packed Dimensions:
 HxWxD mm : 850x690x280

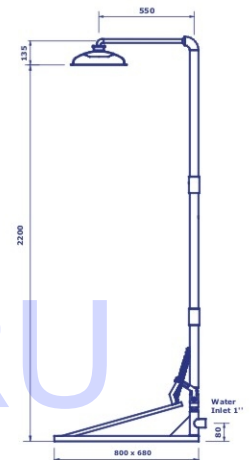

Платформенный с мини панелью

ACCESSORIES

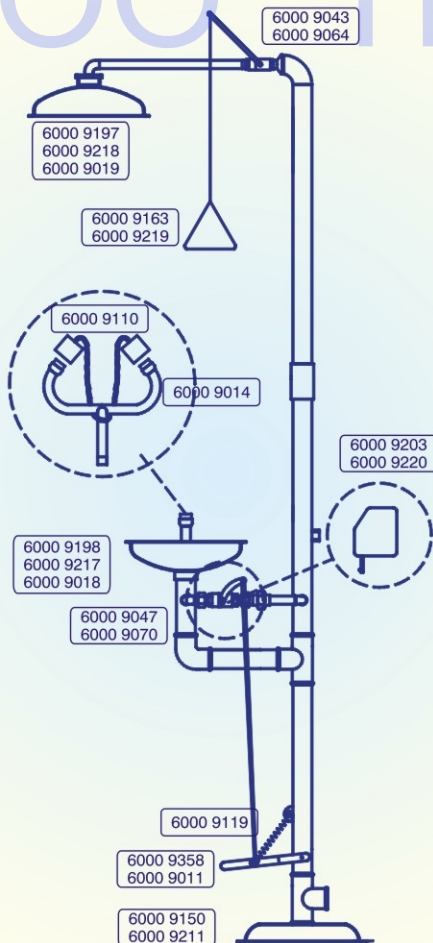

	Old P/N	New P/N
Shower Head - Stainless Steel	1590 1000	6000 9197
Shower Head - Painted Steel	1590 1500	6000 9218
Shower Bowl - Stainless Steel	1590 2000	6000 9198
Shower Bowl - Painted Steel	1590 2500	6000 9217
Shower Head - ABS plastic	1590 4000	6000 9019
Shower Bowl - ABS plastic	1590 5000	6000 9018
Floor mount part - Stainless Steel	1590 6000	6000 9150
Floor mount part - Painted Steel	1590 6500	6000 9211
Spray Nozzle	1590 0300	6000 9111
Foot Panel- Stainless Steel	1590 0400	6000 9358
Foot Panel - Painted Steel	1590 0500	6000 9011
Dusty Covers	1590 0600	6000 9110
Twin Spray Nozzles (complete)	1590 0700	6000 9014
Spring	1590 0100	6000 9119
1/2" Ball Valve - Stainless Steel	1501 1002	6000 9047
1/2" Ball Valve - Brass	1501 1004	6000 9070
1" Ball Valve - Stainless Steel	1501 1003	6000 9043
1" Ball Valve - Brass	1501 1005	6000 9064
1/2" Valve Handle - Stainless Steel	1501 1006	6000 9203
1/2" Valve Handle - Painted Steel	1501 1007	6000 9220
1" Valve Pull Handle - Stainless Steel	1501 1008	6000 9163
1" Valve Pull Handle - Painted Steel	1501 1009	6000 9219

Type	Model	Pipe and fittings material	Control mechanism	Part Numbers
EYEWASH FOUNTAINS	Countertop	Stainless Steel	Push Handle Control	15 01 20 00
		Galvanised and Painted	Push Handle Control	15 01 25 05
	Countertop Laboratory	Stainless Steel	Push Handle Control	15 01 20 20
		Galvanised and Painted	Push Handle Control	15 01 25 25
	Wall with flange	Stainless Steel	Push Handle Control	15 01 10 00
		Galvanised and Painted	Push Handle Control	15 01 15 00
	Wall with bracket	Stainless Steel	Push Handle Control	15 01 11 00
		Galvanised and Painted	Push Handle Control	15 01 16 00
	Wall with flange	Stainless Steel	Treadle Foot Control	15 01 12 00
		Galvanised and Painted	Treadle Foot Control	15 01 17 00
	Wall with flange and cover	Stainless Steel	Push Handle Control	15 01 13 00
		Galvanised and Painted	Push Handle Control	15 01 18 00
	Pedestal	Stainless Steel	Push Handle Control	15 01 30 00
		Galvanised and Painted	Push Handle Control	15 01 35 00
	Pedestal	Stainless Steel	Treadle Foot Control	15 01 40 00
		Galvanised and Painted	Treadle Foot Control	15 01 45 00
	Pedestal with Support	Stainless Steel	Panel Control for Shower	15 01 50 00
		Galvanised and Painted	Panel Control for Shower	15 01 55 00
Freeze-Proof with automatic valve	Stainless Steel	Push Handle Control	15 01 60 00	
	Galvanised and Painted	Push Handle Control	15 01 65 00	
Freeze-Proof with underground valve	Stainless Steel	Treadle Foot Control	15 01 70 00	
	Galvanised and Painted	Treadle Foot Control	15 01 75 00	

EMERGENCY SHOWERS	Pedestal	Stainless Steel	Push Handle Control	15 02 10 00
		Galvanised and Painted	Push Handle Control	15 02 15 00
	Pedestal	Stainless Steel	Treadle Foot Control	15 02 20 00
		Galvanised and Painted	Treadle Foot Control	15 02 25 00
	Wall with exposed piping	Stainless Steel	Push Handle Control	15 02 30 00
		Galvanised and Painted	Push Handle Control	15 02 35 00
	Wall with ball valve	Stainless Steel	Push Handle Control	15 02 40 00
		Galvanised and Painted	Push Handle Control	15 02 45 00
	Pedestal with Support	Stainless Steel	Panel Control for Shower	15 02 50 00
		Galvanised and Painted	Panel Control for Shower	15 02 55 00
	Pedestal with mini panel	Stainless Steel	Panel Control for Shower	15 02 80 00
		Galvanised and Painted	Panel Control for Shower	15 02 85 00
	Freeze-Proof with automatic valve	Stainless Steel	Push Handle Control	15 02 60 00
		Galvanised and Painted	Push Handle Control	15 02 65 00
	Freeze-Proof with underground valve	Stainless Steel	Treadle Foot Control	15 02 70 00
		Galvanised and Painted	Treadle Foot Control	15 02 75 00
	Freeze-Proof with behind wall valve	Stainless Steel	Push Handle Control	15 02 40 10
		Galvanised and Painted	Push Handle Control	15 02 45 10
Freeze-Proof with double valve	Stainless Steel	Panel Control for Shower	15 02 80 80	
	Galvanised and Painted	Panel Control for Shower	15 02 85 85	

Type	Model	Pipe and fittings material	Control mechanism	Part Numbers
COMBINATIONS UNITS EYEWASH /SHOWERS	Pedestal	Stainless Steel	Push Handle for Eyebath - Pull Rod Control for Shower	15 03 10 00
		Galvanised and Painted	Push Handle for Eyebath - Pull Rod Control for Shower	15 03 15 00
	Pedestal	Stainless Steel	Treadle for control for Eyebath - Pull Rod Control for Shower	15 03 20 00
		Galvanised and Painted	Treadle for control for Eyebath - Pull Rod Control for Shower	15 03 25 00
	Pedestal	Stainless Steel	Push Handle for Eyebath - Treadle foot Control for Shower	15 03 30 00
		Galvanised and Painted	Push Handle for Eyebath - Treadle foot Control for Shower	15 03 35 00
	Wall with exposed piping	Stainless Steel	Push Handle Control	15 03 40 00
		Galvanised and Painted	Push Handle Control	15 03 45 00
	Pedestal with Support	Stainless Steel	Treadle Foot Control for Eyebath Panel Control for Shower	15 03 50 00
		Galvanised and Painted	Treadle Foot Control for Eyebath Panel Control for Shower	15 03 55 00
	Pedestal with Support Light weight cabinet	Stainless Steel	Treadle Foot Control for Eyebath Panel Control for Shower	15 03 50 50
		Galvanised and Painted	Treadle Foot Control for Eyebath Panel Control for Shower	15 03 55 55
	Pedestal with mini panel	Stainless Steel	Treadle Foot Control for Eyebath Panel Control for Shower	15 03 80 00
		Galvanised and Painted	Treadle Foot Control for Eyebath Panel Control for Shower	15 03 85 00
	Freeze-Proof with automatic valve water inlet from ground	Stainless Steel	Push Handle Control	15 03 60 00
		Galvanised and Painted	Push Handle Control	15 03 65 00
	Freeze-Proof with automatic valve water inlet from up	Stainless Steel	Treadle Foot Control	15 03 60 60
		Galvanised and Painted	Treadle Foot Control	15 03 65 65
	Freeze-Proof with double valve	Stainless Steel	Panel Control for Shower	15 03 80 80
		Galvanised and Painted	Panel Control for Shower	15 03 85 85
Freeze-Proof with underground valve	Stainless Steel	Push Handle Control	15 03 90 00	
	Galvanised and Painted	Push Handle Control	15 03 95 00	

